

Aristel Networks

AV8

INSTALLATION GUIDE

Version number 1.0 issued March 2001

Aristel Networks Pty Ltd
Unit 3A, 100 Station Street
Nunawading VIC 3161
Telephone: 03 9837 2300
Facsimile: 03 9872 4433

INTRODUCTION

This manual provides the detailed procedures for installing the OMNI AV-8 Key Telephone System. Read this entire section before proceeding with the actual installation.

Prior to installation carefully inspect all packages for evidence of damage and compare the equipment received against equipment ordered to ensure ALL components have been received.

SITE REQUIREMENT

- The Key System Unit (KSU) should be installed in a clean, dry and secure location accessible only by authorized personnel. The location must have adequate ventilation and the temperature range within 0 ~ 45° C with a 10 ~ 90% non-condensing relative humidity.
- The installation site should have sufficient room to mount the KSU on a wall, along with the necessary connecting blocks and ancillary equipment. The installation site should not be in areas subject to static electricity (eg. dry copiers, electric welders), or vibration (eg. heavy machinery).
- It is the customer's responsibility to provide a dedicated 240VAC/50Hz 10 Amp mains power outlet. Line Isolation Units (LIUs) must be provided if an external music source or optional external paging equipment is installed.

FIG 1.1 KSU INSTALLATION LAYOUT DIAG.

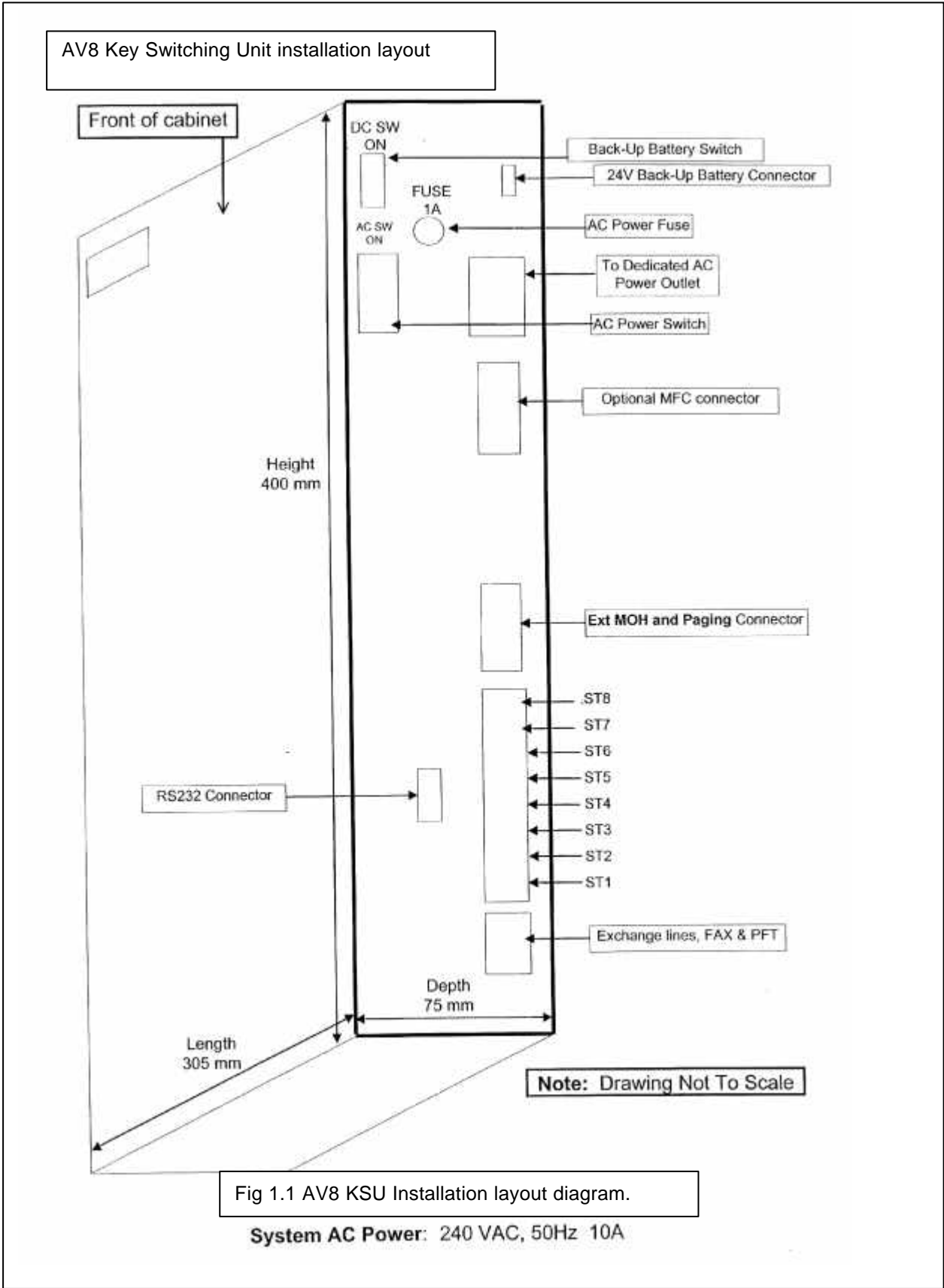

System Inter-Circuit Connector Layout

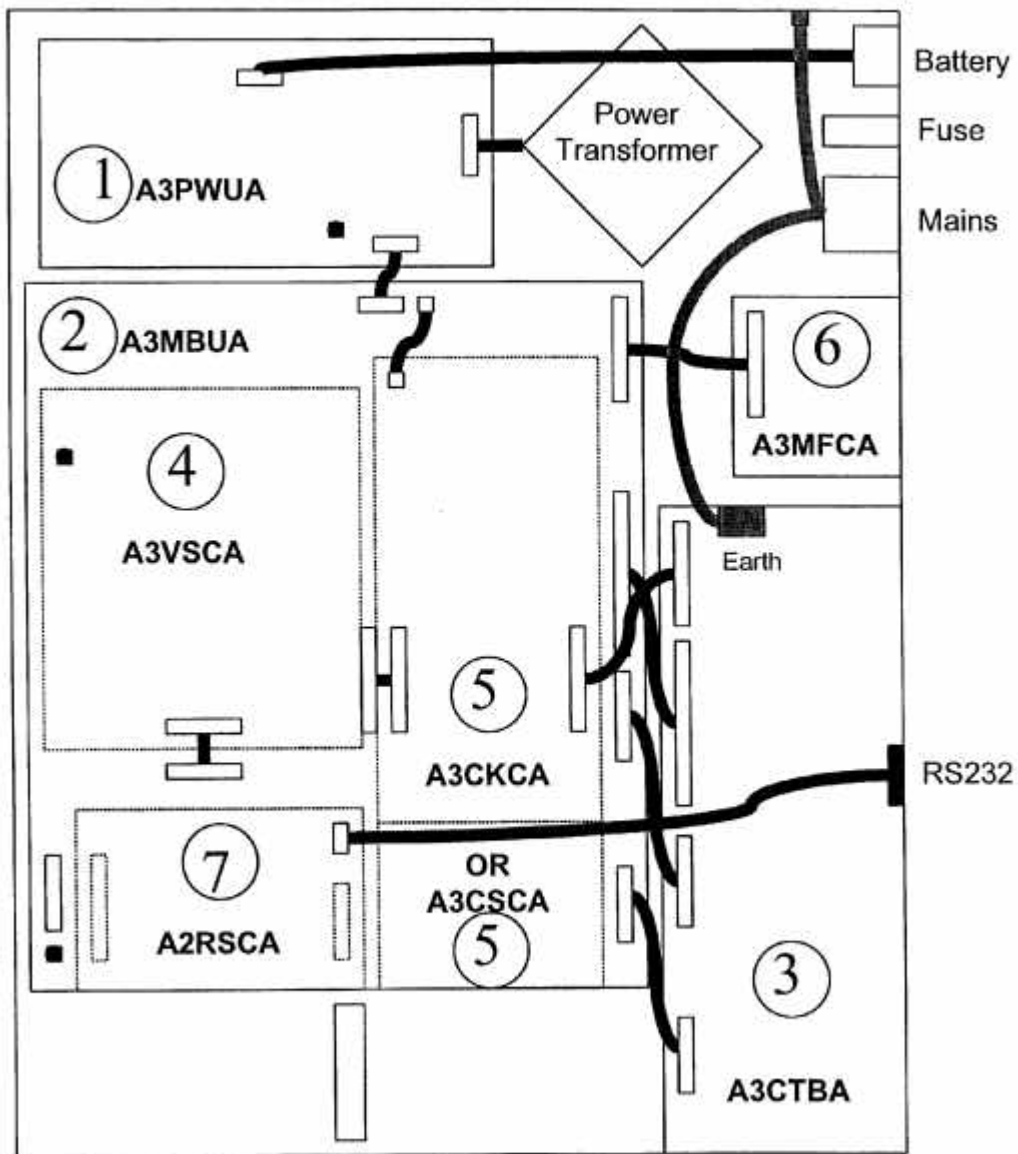
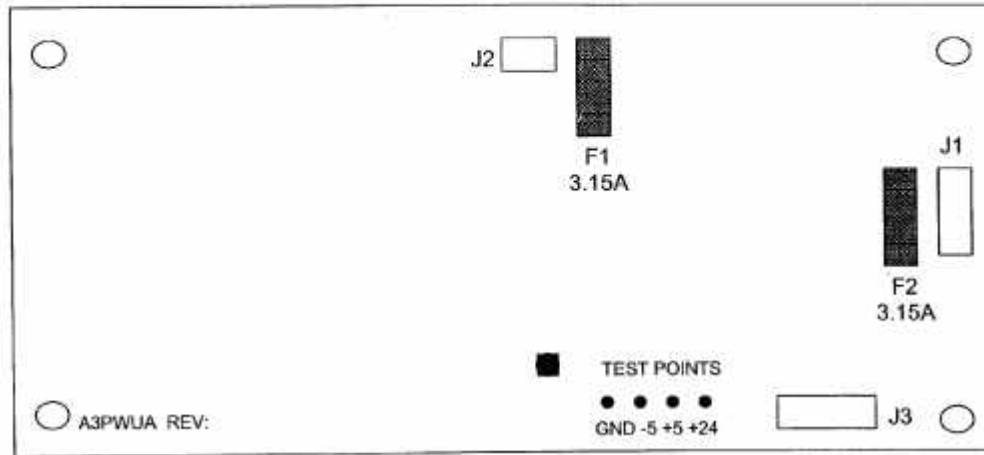

Fig. 1-2. System Circuit Board Layout and Connectors

- | | |
|---------------------------------------|---|
| 1. A3PWUB (Power Unit) | 5. A3CKCA (1 CO Line & 2 Key Station card) |
| or | |
| 2. A3MBUA (Mother Board) | 5. A3CSCA (1 CO Line & 2 SLTs card) |
| 3. A3CTBA (Terminal Block) | 6. A3MFCA (Multi Function card) |
| 4. A3VSCA (Voice Service card) | 7. A3RSCA (RS232 card) |

System Printed Circuit Board (PCB) Modules

A3PWUA (Power Supply) Standard



A3PWUA Connectors and Test Points

1. **GND** :Ground Reference Test Point
2. **-5V** :Test Point for -5V DC output
3. **+5V** :Test Point for +5V DC output
4. **+24V** :Test Point for +24V DC output
5. **J1** :Connect to AC transformer (240VAC input)
6. **J2** :Connect to External Backup Battery connector
7. **J3** :Connect to A3MBUA
8. **LED 1** :Indicates +5V DC is present when on
9. **F1** :Fuse 1, backup battery reverse polarity protection. 3.15 A Fast Blow
10. **F2** :Fuse 2, DC protection (+5V, -5V, +24V) 3.15A Fast Blow

A3MBUA (Mother Board) Standard

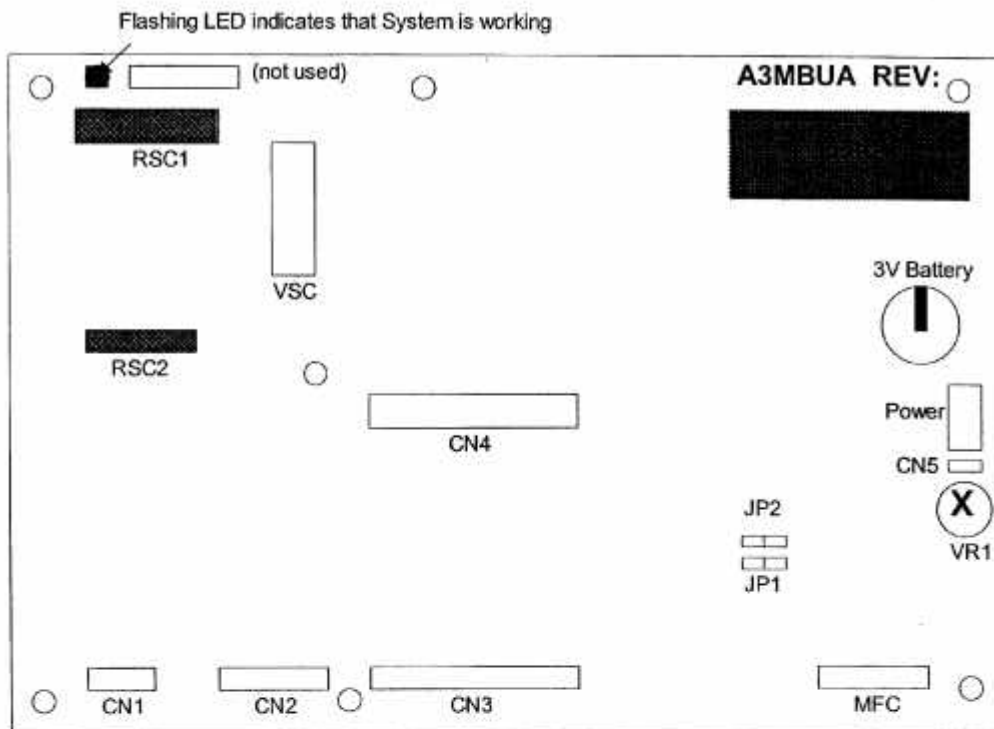

A3MBUA LAYOUT DIAGRAM

Important note: Remove tag from 3V lithium battery to enable system memory backup.

A3MBUA Connectors, Jumpers and Controls

1. **JP1:** Music on Hold source (MOH)

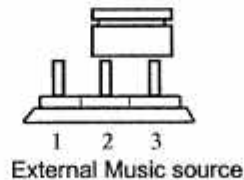
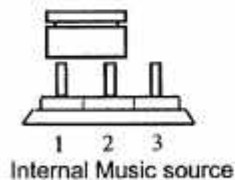

2. **JP2:** Background Music source (BGM)

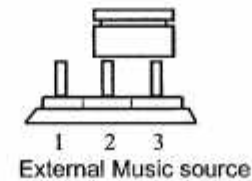
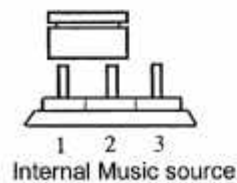

3. **VR1:** Volume Level adjustment for the internal music source.

- | | | |
|-----|------------------------|---|
| 4. | 3 Volt Battery | Memory backup Battery |
| 5. | VSC | Connection to Con1 on ASVSC card |
| 6. | RSC1 & RSC2 | Connection for RSCA card |
| 7. | MFC | Connection to CON1 on A3MFCA card |
| 8. | POWER | Connection to J3 on A3PWUA card |
| 9. | CN1 | Connection to CN1 on A3CTBA card |
| 10. | CN2 | Connection to CN3 on A3CTBA card |
| 11. | CN3 | Connection to CN4 on A3CTBA card |
| 12. | CN4 | Connection to CN1 on A3CSCA or A3CKCA cards |
| 13. | CN5 | Connection to CN3 on A3CSCA card |

A3CTBA (Clip Terminal Board) Standard

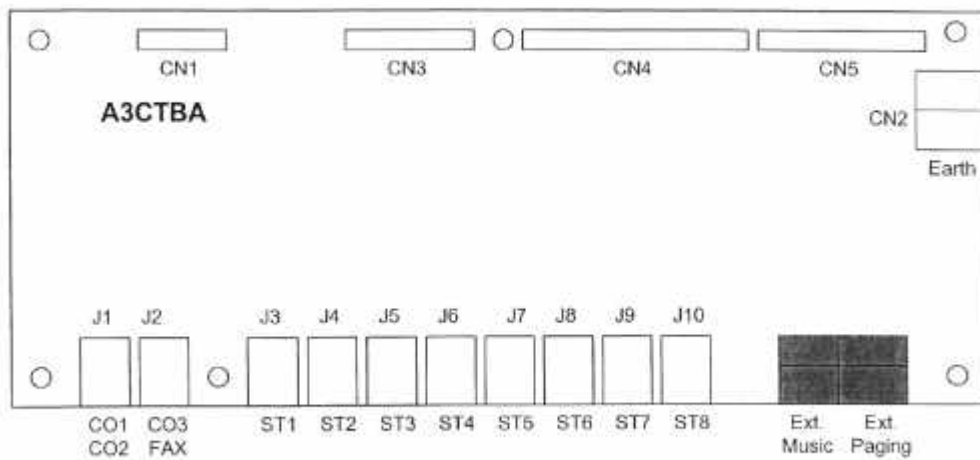

A3CTBA LAYOUT DIAG

A3CTBA Connectors

1. **CN1** Connection to CN1 on A3MBUA card
2. **CN2** Connection to Mains Earth
3. **CN3** Connection to CN2 on A3MBUA card
4. **CN4** Connection to CN3 on A3MBUA card
5. **CN5** Connection to CN2 on A3CKCA or A3CSCA cards
6. **J1-J2** Connection to C.O. lines 1-3 and the FAX/PFT
7. **J3-J10** Connection to Stations 11-16 and optional Stations/SLTs
8. **CN6** Connection to External Music source and External PA amplifier

A3CKCA (Exchange Line & 2 Key Station Card) Optional

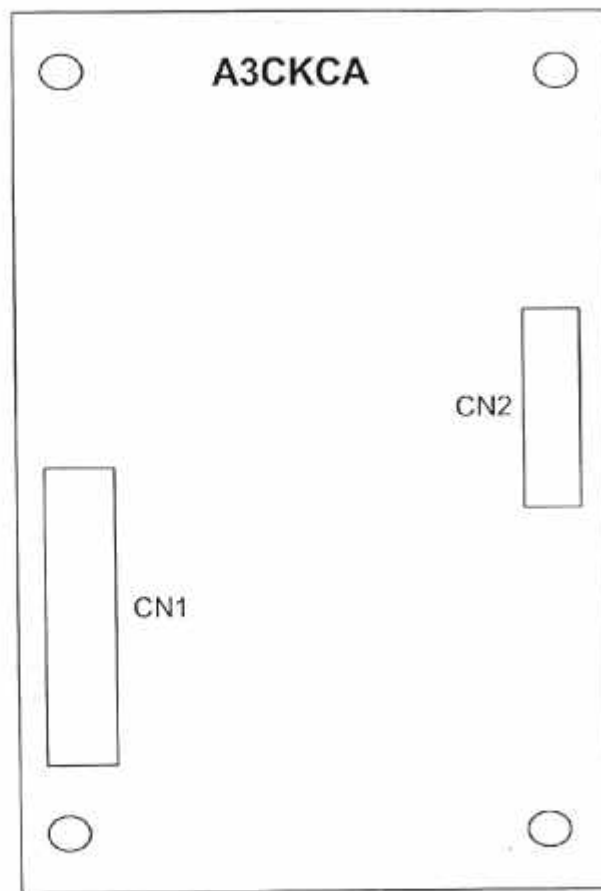

A3CKCA LAYOUT DIAGRAM

1. **CN1** Connection to CN4 on A3MBUA card
2. **CN2** Connection to CN5 on A3CTBA card

A3CSCA (Exchange Line & 2 Single Line Telephone (SLT) Card) Optional

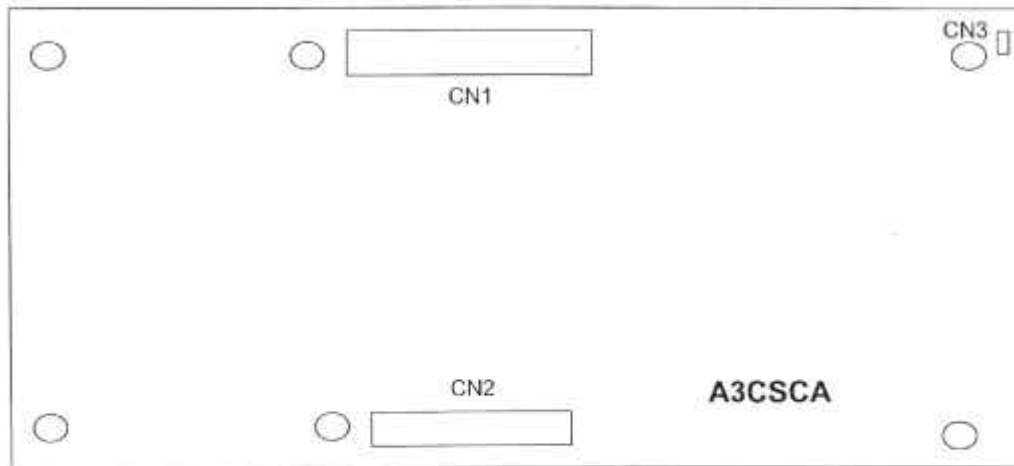

A3CSCA LAYOUT DIAGRAM

A3CKCA Connectors

1. **CN1:** For connection to CN4 on A3MBUA card.
2. **CN2:** For connection to CN5 on A3CTBA card.
3. **CN3:** For connection to CN5 on A3MBUA card.

A3VSCA (Voice Service Card) Optional

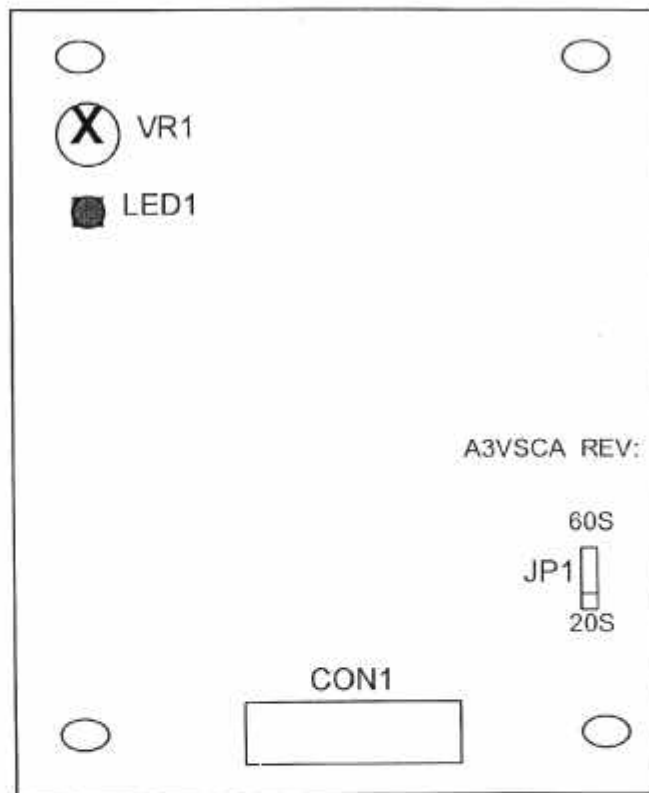

A3VSCA LAYOUT DIAGRAM

A3VSCA Connectors, Jumpers and Controls

1. **LED1:** Indicates that the VSC is in operation.
2. **VR1:** Volume Level Adjustment for replaying.
3. **CON1:** For connection to VSC on A3MBUA card.
4. **JP1:** Jumper for selecting 20 or 60 second voice channel duration.

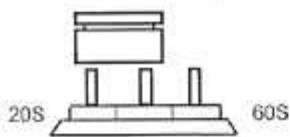

Time duration for each channel is 20 seconds in total

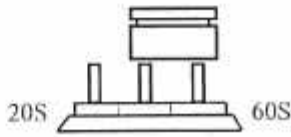

Time duration for each channel is 60 seconds in total

A2RSCA (RS232 Card) Optional

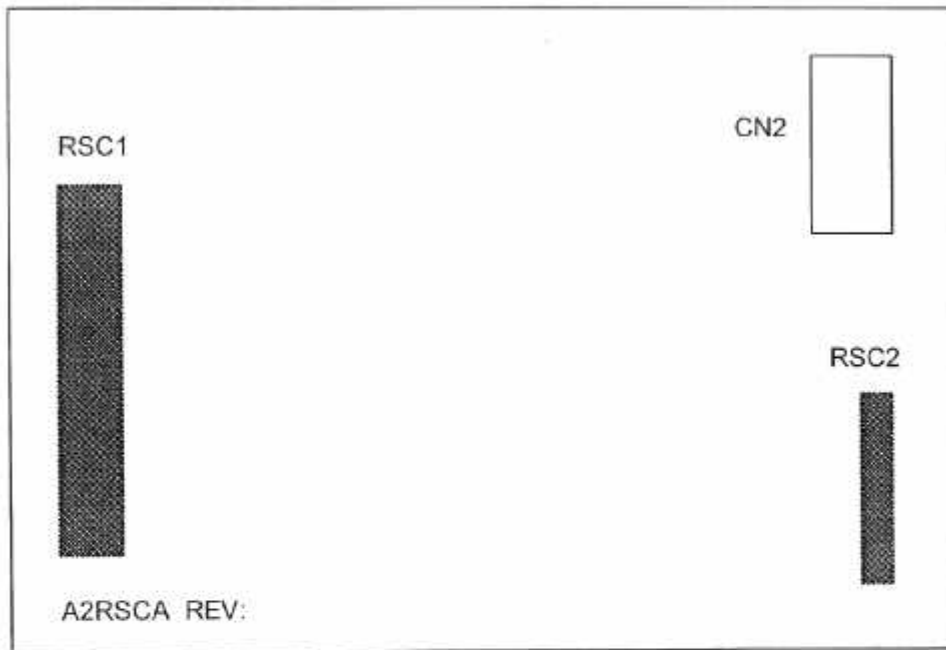

A2RSCA LAYOUT DIAGRAM

A2RSCA Connectors

1. **RSC1:** For connection to RSC1 on A3MBUA card.
2. **RSC2:** For connection to RSC2 on A3MBUA card.
3. **CON2:** For connection of RS232 Ribbon connector to side of KSU.

A3MFCA (Multi Function Card) Optional

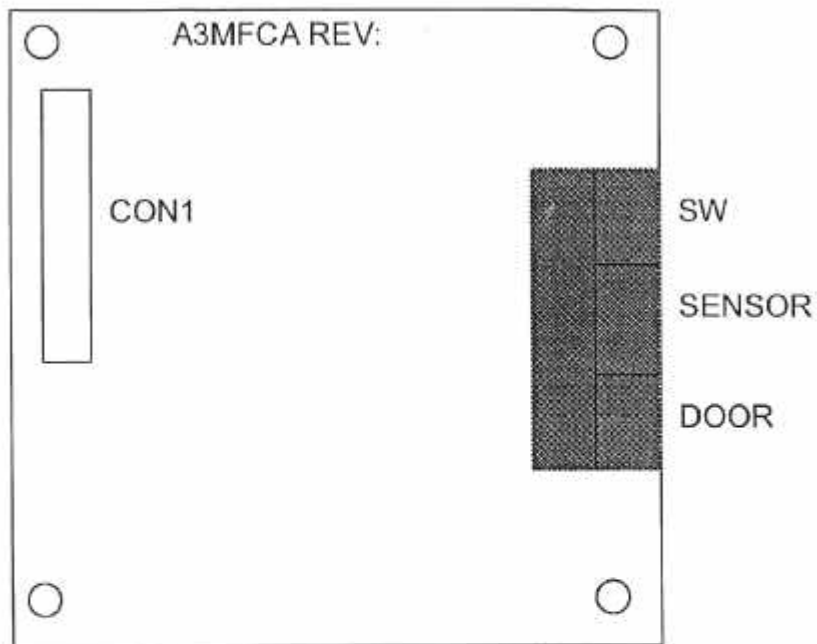

A3 MFCA LAYOUT DIAGRAM

A3MFCA Connectors

1. **CON1:** For connection to MFC on A3MBUA card.
2. **DOOR:** For connection to two wire UF series Door Station.
3. **SENS:** For connection of external sensor/switching device (open / closed)
4. **SW:** For connection of relay output to operate external device (Normally Open)

System Installation and Cabling

System Wall Mounting Installation

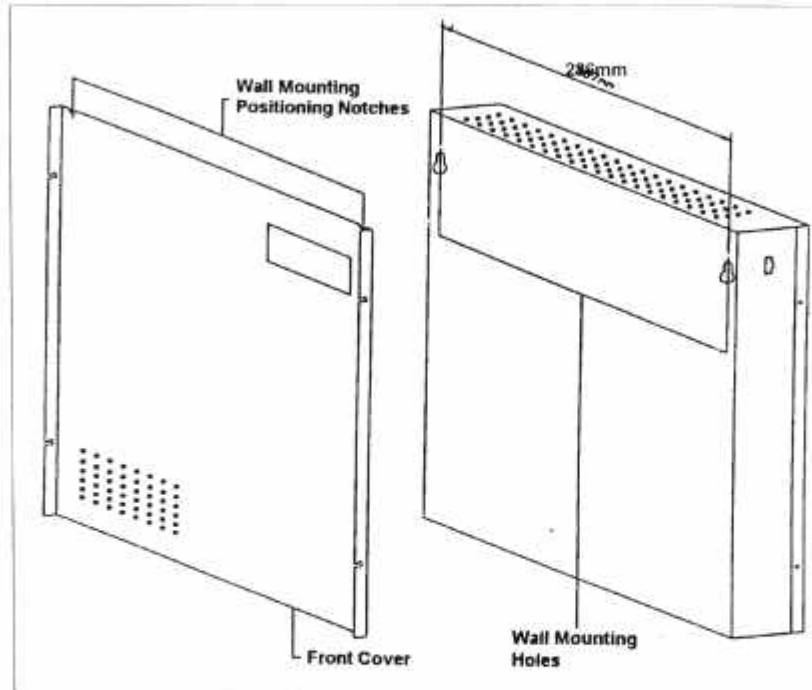

Fig. 1-16. System Wall Mount Layout

- * Remove the system front cover.
- * Use the two notches at the top of the front cover to mark the position on the wall where the unit is to be mounted.
- * Drive appropriate mounting screws into the wall, according to marked positions.
- * Suspend the AV8 system on the wall by matching the mounting holes on the back cover to the screws.

WARNING! Some brick/concrete walls may sweat or leak so an appropriate backing board may be required to mount the system on.

Facsimile Connection

The AV 8 system can support a FAX machine connected via the CO3/FAX RJ socket. When using this point for connection, the following should be noted.

1. The RJ connector is a 6P-6C connector using contacts 3 & 4 for the 3rd C.O. line and contacts 1 & 6 for the FAX machine or for the PFT telephone (refer to diagram on page 17) **NOTE! Contacts 2 and 5 are not used.**
2. The Fax machine, when in use, is connected in parallel with C.O. line 2
3. Program zone 220 (FAX MONITOR) must be set to 1, to enable the Fax Monitor feature. With zone 220 enabled, the system monitors C.O. 2 and will deny system access to the line if it is in use by the Fax machine.
4. Incoming Ring Assignment (zones 600/601) can be set so that no handsets ring on the fax line. The line can be used for outgoing calls if desired.

Power Fail Telephone (PFT) Connection

An SLT can be connected for use during Power Fail conditions. The SLT is connected in parallel with the Fax machine.

NOTE! Under Power Fail conditions, the SLT is connected in parallel with C.O.2

System Back-Up Battery Installation

External Cabling Connection: Connect the two wire cable (**Male Connector** from the Battery Box) to the system Back-Up Battery **Female Connector** as shown below.

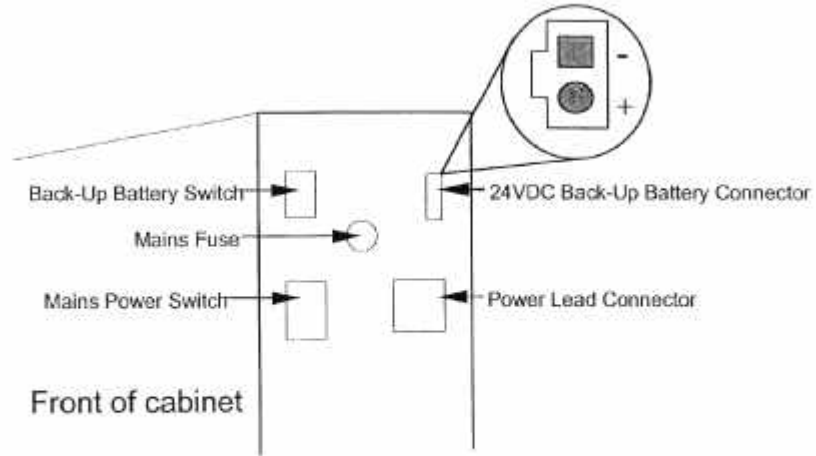

External Backup battery installation connection diagram

Local Programming Cable

The Local Programming Cable is a DB9 to DB9 serial cable that is used when the RSCA card is installed for Local Programming and SMDR data retrieval.

The cable allows the Installer to upload and download the systems program to a PC using the SMxx software programme. The site data can be changed and downloaded as desired.

Pin to Pin connection.

DB9 pin	DB9 Pin	Signal
2	2	SD
3	3	RD
4	4	DTR
5	5	SG
6	6	DSR

System, C.O. Line, Key Telephone and Auxiliary Equipment Cabling

C. O. Line Connection

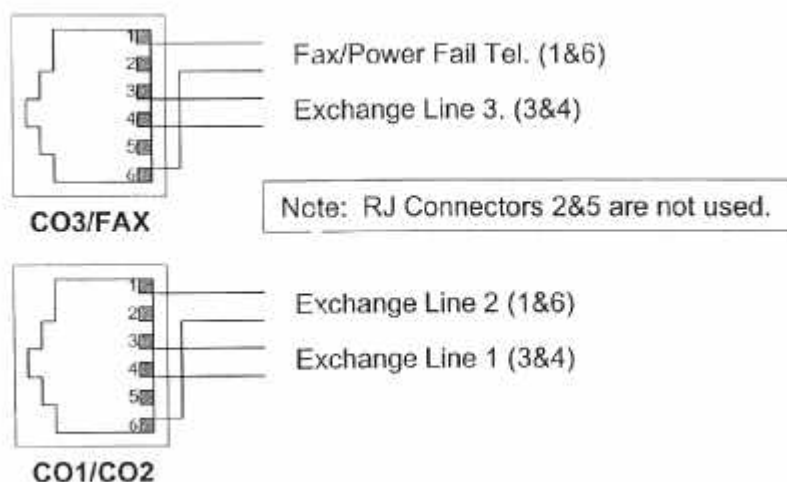

Where two C. O. Lines are connected to the same socket (eg: C.O.1 & C.O.2), ensure that the polarity of the lines is the same. This will reduce the possibility of tracking and corrosion in humid climates.

Key Station Cabling

When terminating cables on sockets please observe the following practices.

- Leave at least 150 mm slack cable in wall cavity
- Leave 20-30 mm of wire in socket for maintenance reasons
- Do not terminate spare wires on idle connections

DATA PAIR CONNECTION = PIN 2 +ve AND PIN 5 –ve

VOICE PAIR CONNECTION = PIN 3 AND PIN 4 NON-POLARITY SENSITIVE.

- Sockets are wired using 2-pair, 3-pair or 4-pair cables. Designated pairs for commonly used cables are provided in Table xx.

Pair	Leg	2-pair Cable	3-pair Cable	CAT 5 Cable	Function
1	AT AR	White Blue	White Blue	Blue Blue-White	Audio Pair
2	BT BR	Red Black	Red Black	Orange Orange-White	Data Pair
3	OT OR		Orange Green	Green Green-White	OHCA Pair
4				Brown Brown-White	Not Required

R = Ring -ve and T = Tip +ve

Basic wiring Table — Typical cable pair colours for Station wiring terminations

Standard Key Station Installation Cabling

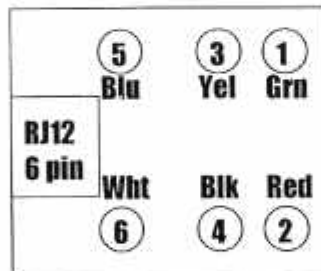

6 Pin RJ12 Socket Connections

Keyphone and Single Line Telephone Termination Wiring Configuration

RJ12 6 pin Connector	Keyphone	Keyphone OHCA	SLT
1 (Green) 2 (Red)	Audio	Audio	Audio
3 (Yellow) 4 (Black)	Data T (+ve) Data R (-ve) (Note 1)	Data T (+ve) Data R (-ve) (Note 1)	Not Required
5 (Blue) 6 (White)	Not Required	2 nd Audio Pair OHCA (Note 2)	Not Required

Note:

1. If the keyphone does not work when you first turn it on you may have the Data pair reversed.
2. OHCA Audio Pair can be taken from any unused Keyphone Port.

Installation of Optional Equipment.

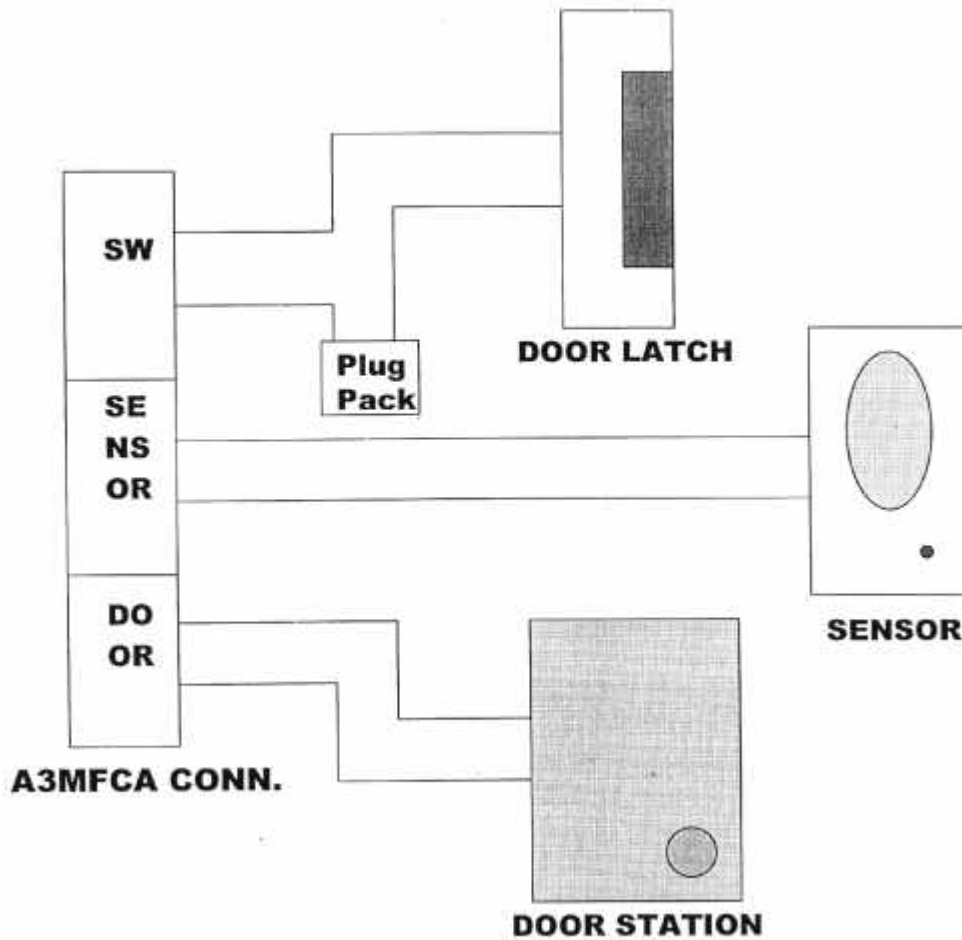

The A3MFCA termination provides connection for a Door Station (DOOR), Door Latch (SW) and a Sensor or Alarm input (SENSOR).

Only one Door Phone (2 wire) can be connected to the AV8 system.

The Relay can be used to operate an electric Door Latch or to operate another device as required. Refer to programme Zone 302 to set the operation of the relay. The relay contacts are rated at 24V DC, 1 Amp.

The single Sensor/Alarm Contact is programmed in Zone 303 for whatever function that is required. The condition of the Sensor under operating conditions, can be either normally open or normally closed. This is selected in Zone 303.

Installation of External MOH/BGM and External Paging

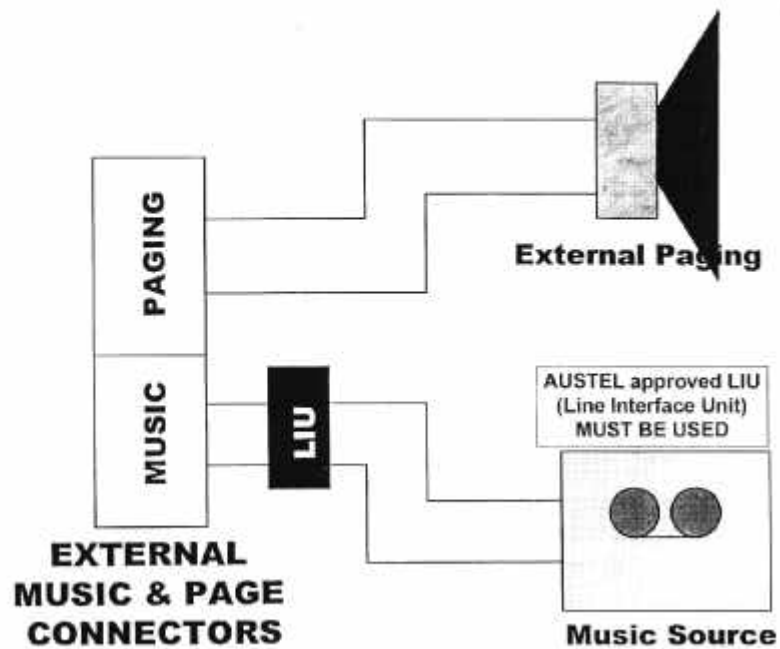

Both the External Music source and the External Paging Amplifier **MUST** be connected through an approved L.I.U. The jumpers JP1 and JP2 must be set for external music if it is to be supplied. The volume control on the Mother Board only controls the Internal Chimes. It has no control of the External Music source.